

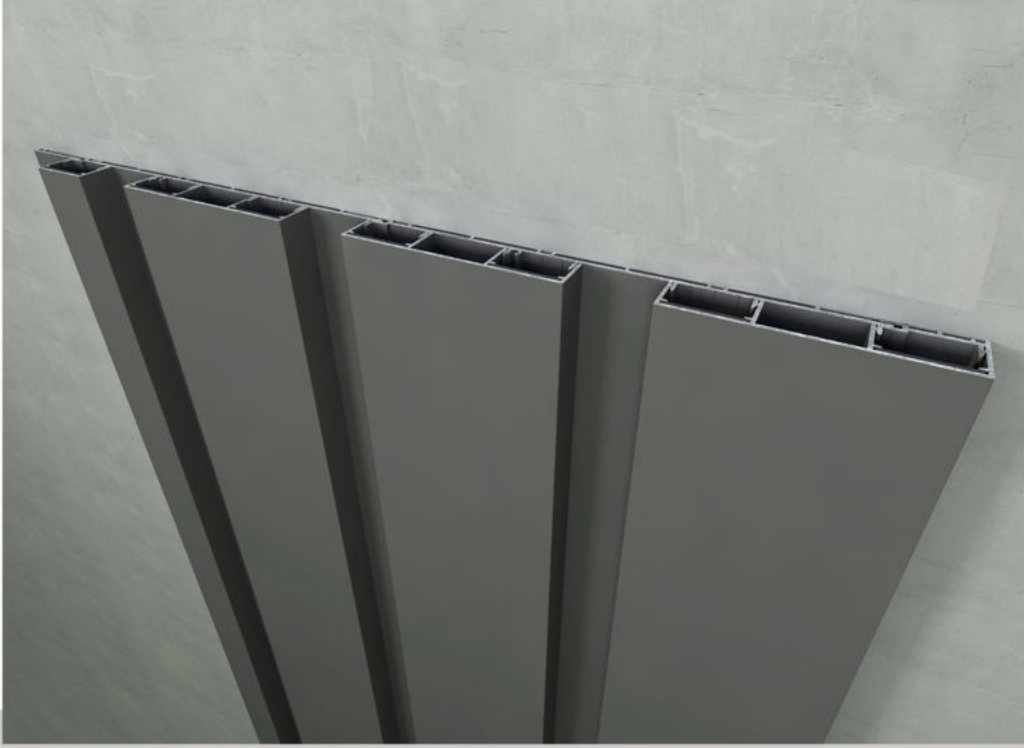

Dış Mekan Sistem
Outdoor System

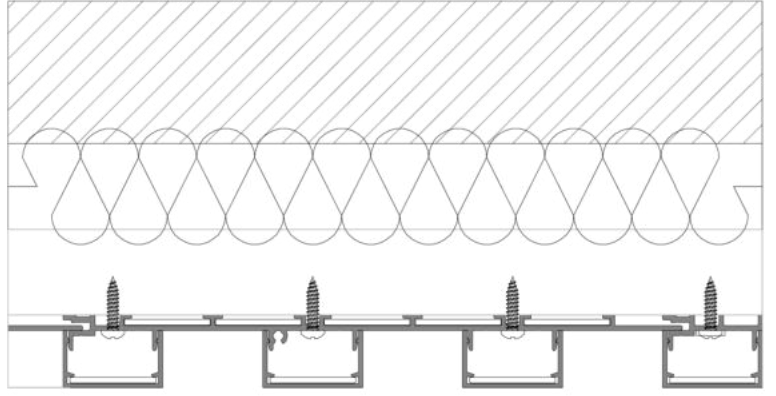









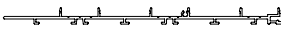
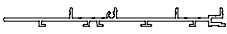

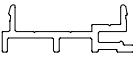
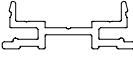
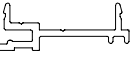
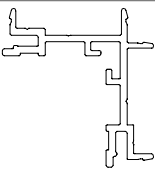
ARTLINE CL35

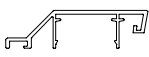

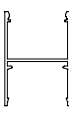
TEKNİK ÖZELLİKLER / TECHNICAL PROPERTIES

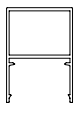
KAPAK ALTI GÖVDE PROFİL GENİŞLİĞİ / LID SUBBODY PROFILE WIDTH	147 - 217 mm
KAPAK PROFİL GENİŞLİĞİ / LID PROFILE WIDTH	35 - 105 mm
KAPAK PROFİL YÜKSEKLİĞİ / LID PROFILE HEIGHT	20 - 50 mm
PROFİL ET KALINLIĞI / PROFILE THICKNESS	1,5 - 1,8 mm
KAPAK ALTI GÖVDE PROFİLİ ŞERİT SEÇENEKLERİ/ LID SUBBODY PROFILE STRIP OPTIONS	2 ve 3
LEDLİ KAPAK PROFİLİ / LED LID PROFILE	✓
BAŞLANGIÇ GÖVDE PROFİLİ / STARTING BODY PROFILE	✓
BİTİŞ GÖVDE PROFİLİ / ENDING BODY PROFILE	✓
ORTA BİRLEŞİM GÖVDE PROFİLİ / MIDDLE JUNCTION BODY PROFILE	✓
BAĞIMSIZ ALT GÖVDE PROFİLİ / INDEPENDENT SUBBODY PROFILE	✓
90 KÖŞE DÖNÜŞ ALT GÖVDE PROFİLİ / 90 CORNER TURN SUBBODY PROFILE	✓
YATAY VE DÜŞEY PROFİL KULLANIMI USE OF HORIZONTAL AND VERTICAL PROFILES	✓

PROFİL KESİTİ PROFILE SECTION	PROFİL KODU PROFILE CODE	PROFİL ADI PROFILE NAME	Jx cm ⁴	Jy cm ⁴	AĞIRLIK (kg/m) WEIGHT
	14156	3 AKSLI GÖVDE PROFİLİ 3-AXLE BODY PROFILE	-	-	1,504 kg/m
	14157	2 AKSLI GÖVDE PROFİLİ 2-AXLE BODY PROFILE	-	-	1,032 kg/m
	14158	BİTİŞ PROFİLİ ENDING PROFILE	-	-	0,203 kg/m
	14159	BAŞLANGIÇ PROFİLİ STARTED PROFILE	-	-	0,313 kg/m
	14160	GEÇİŞ PROFİLİ TRANSITION PROFILE	-	-	0,343 kg/m
	14161	GEÇİŞ PROFİLİ TRANSITION PROFILE	-	-	0,294 kg/m
	14162	90° KÖŞE DÖNÜŞ PROFİLİ 90° CORNER PROFILE	-	-	0,599 kg/m
	14164	BİTİŞ PROFİLİ (4 mm) FINISH PROFILE (4 mm)	-	-	0,301 kg/m
	14165	YATAY KAPAK PROFİLİ HORIZONTAL COVER PROFILE	-	-	0,694 kg/m
	14166	KAPAK PROFİLİ COVER PROFILE	-	-	0,767 kg/m
	14167	LED UYGULAMALI KAPAK PROFİLİ LED APPLICATION COVER PROFILE	-	-	0,583 kg/m
	14163	LED KAPAK PROFİLİ LED COVER PROFILE	-	-	0,122 kg/m
	14168	KAPAK PROFİLİ COVER PROFILE	-	-	0,686 kg/m
	14169	KAPAK PROFİLİ COVER PROFILE	-	-	0,311 kg/m

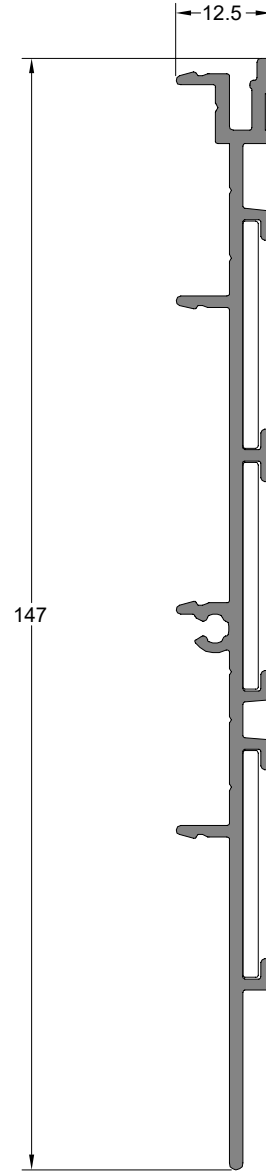
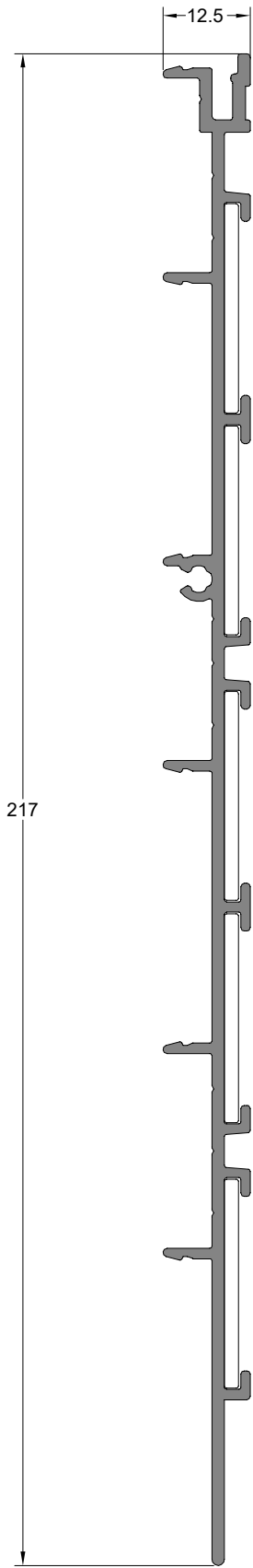

2 Akslı Gövde Profili 2-AXLE BODY PROFILE	Profil Kodu Profile Code	(kg/mt) Weight
	14157	1,032

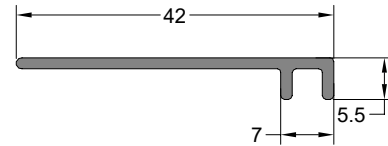

3 Akslı Gövde Profili 3-AXLE BODY PROFILE	Profil Kodu Profile Code	(kg/mt) Weight
	14156	1,504

Bitiş Profili ENDING PROFILE	Profil Kodu Profile Code	(kg/mt) Weight
	14158	0,203

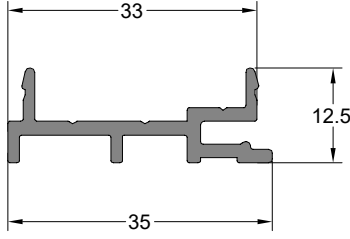

Başlangıç Profili STARTED PROFILE	Profil Kodu Profile Code	(kg/mt) Weight
	14159	0,313

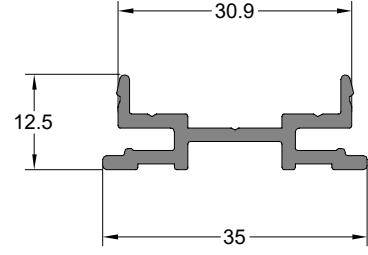

Geçiş Profili TRANSITION PROFILE	Profil Kodu Profile Code	(kg/mt) Weight
	14160	0,343

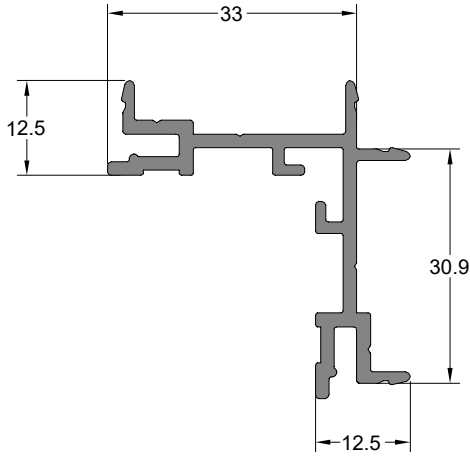

90° Köşe Dönüş Profili 90° CORNER PROFILE	Profil Kodu Profile Code	(kg/mt) Weight
	14162	0,599

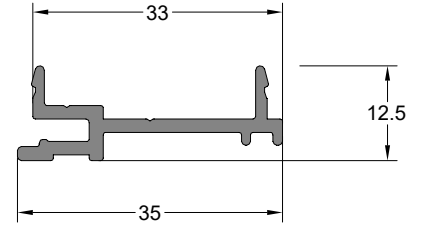

Geçiş Profili TRANSITION PROFILE	Profil Kodu Profile Code	(kg/mt) Weight
	14161	0,294

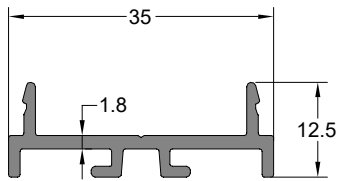

Bitiş Profili (4 mm) FINISHED PROFILE	Profil Kodu Profile Code	(kg/mt) Weight
	14164	0,301

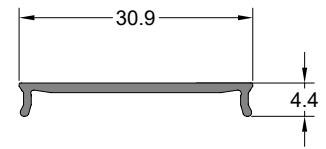

Led Kapak Profili LED COVER PROFILE	Profil Kodu Profile Code	(kg/mt) Weight
	14163	0,122

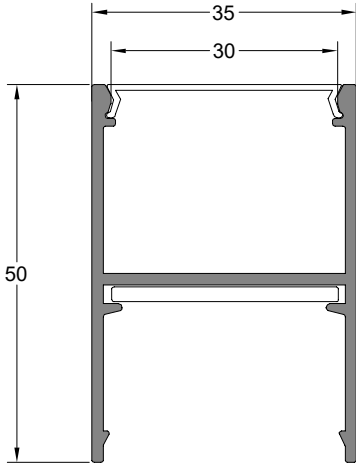

Led Uygulamalı Kapak Profili	Profil Kodu	(kg/mt)
LED APPLICATION COVER PROFILE	Profile Code	Weight
	14167	0,583

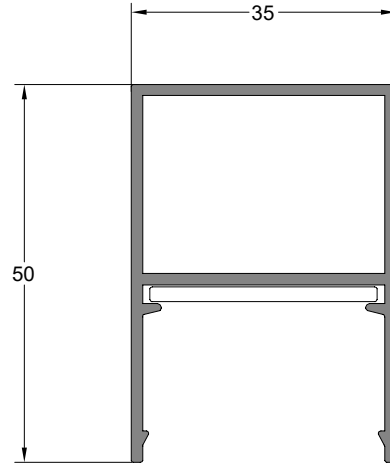

Kapak Profili	Profil Kodu	(kg/mt)
COVER PROFILE	Profile Code	Weight
	14168	0,686

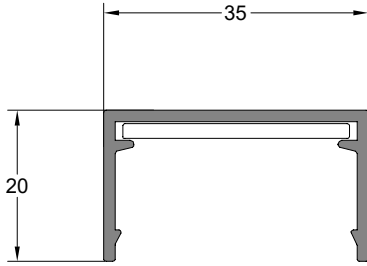

Kapak Profili	Profil Kodu	(kg/mt)
COVER PROFILE	Profile Code	Weight
	14169	0,311

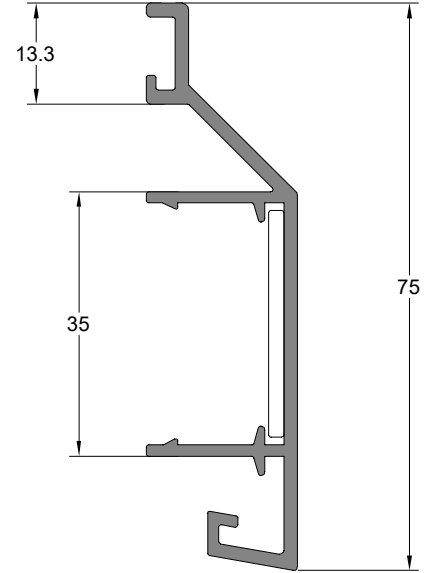

Yatay Kapak Profili	Profil Kodu	(kg/mt)
HORIZONTAL COVER PROFILE	Profile Code	Weight
	14165	0,694

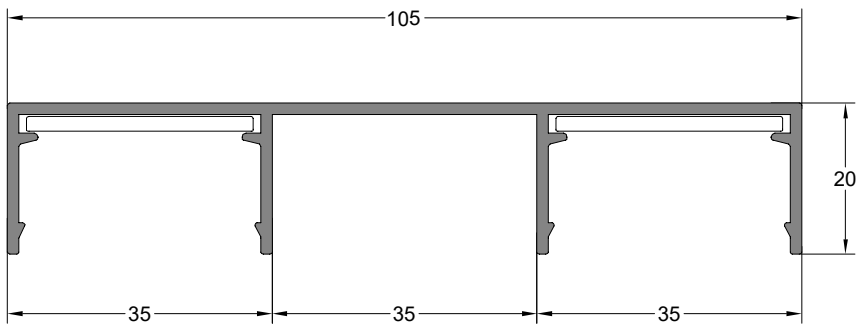

Yan Kapak Profili	Profil Kodu	(kg/mt)
SIDE COVER PROFILE	Profile Code	Weight
	14166	0,767

ART-CV-30

KAPAK

FONKSIYONLARI

ART-CV-30

COVERED

FUNCTIONS

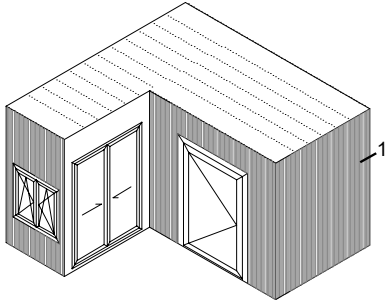

İÇ
(INSIDE)

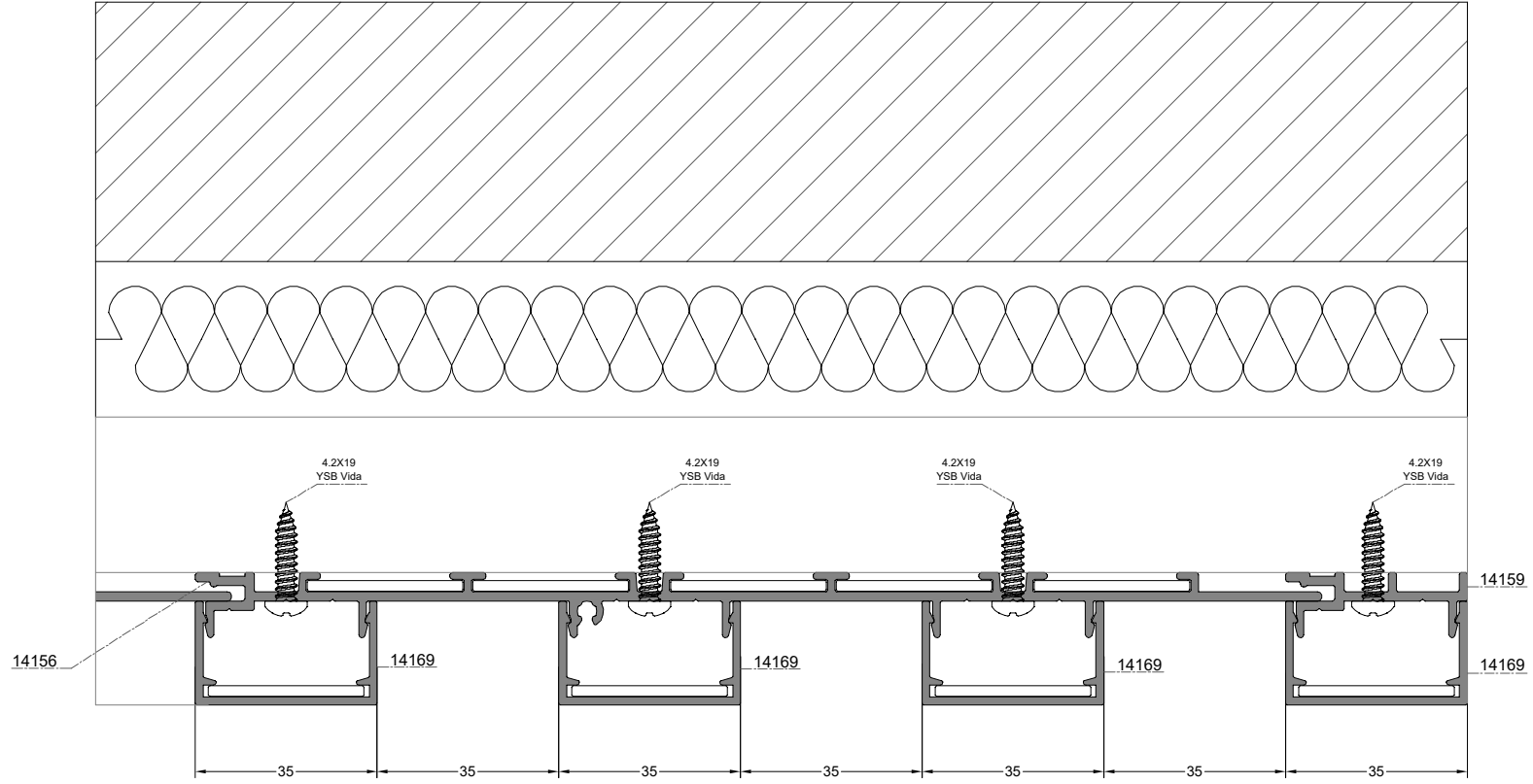

DIŞ
(OUTSIDE)

D-1

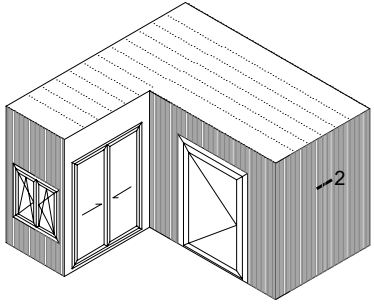

İÇ
(INSIDE)

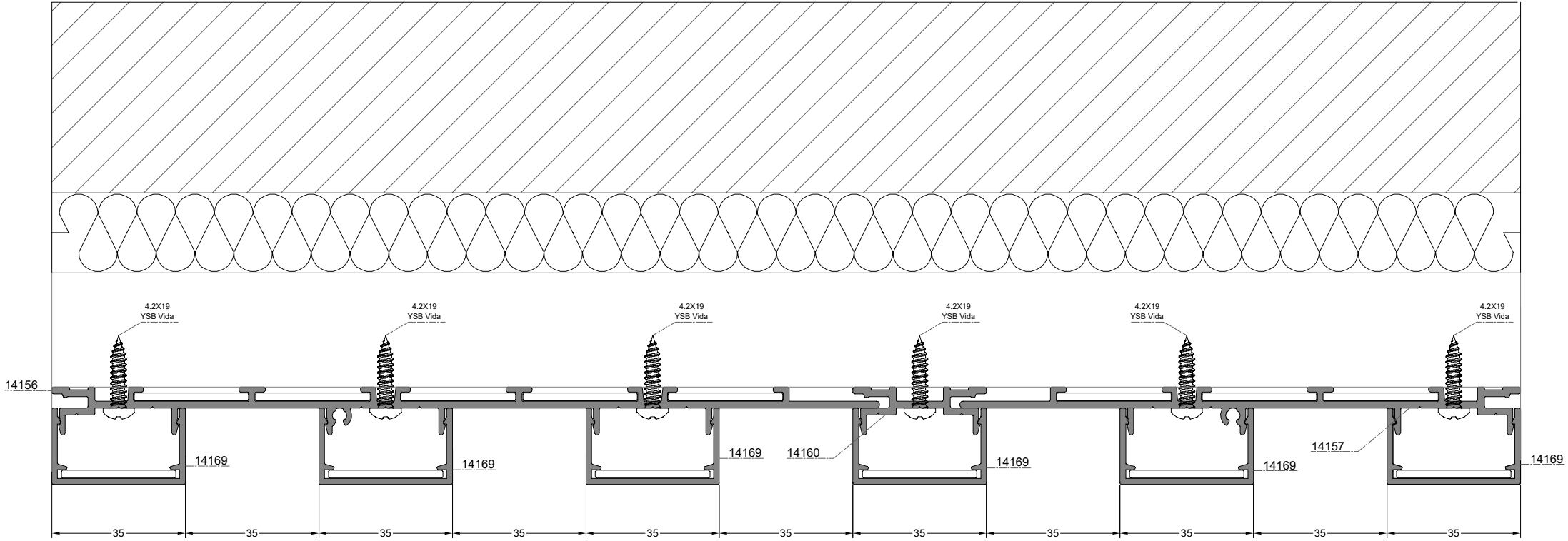

DIŞ
(OUTSIDE)

D-2

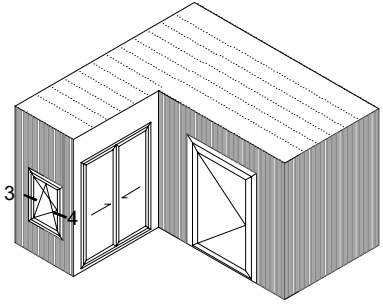

İÇ
(INSIDE)

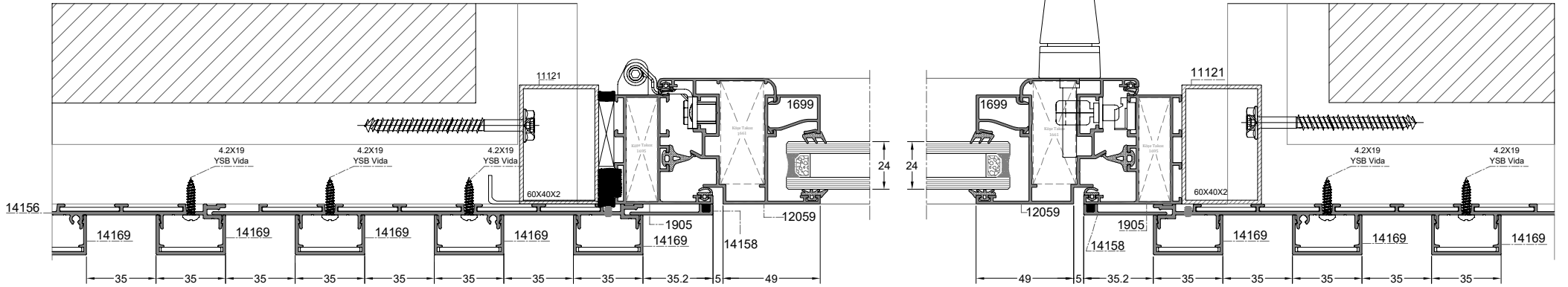

D-3

DIŞ
(OUTSIDE)

D-4

ÖLÇEK: 1/2
SCALE: 1/2

İÇTEN KÖŞE DÖNÜŞ DETAYI
INWARD COVERED DETAIL

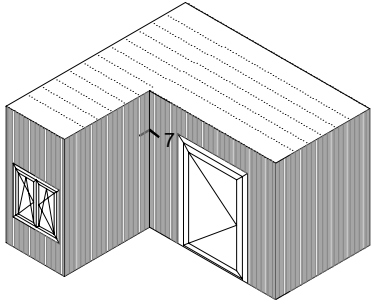

İÇ
(INSIDE)

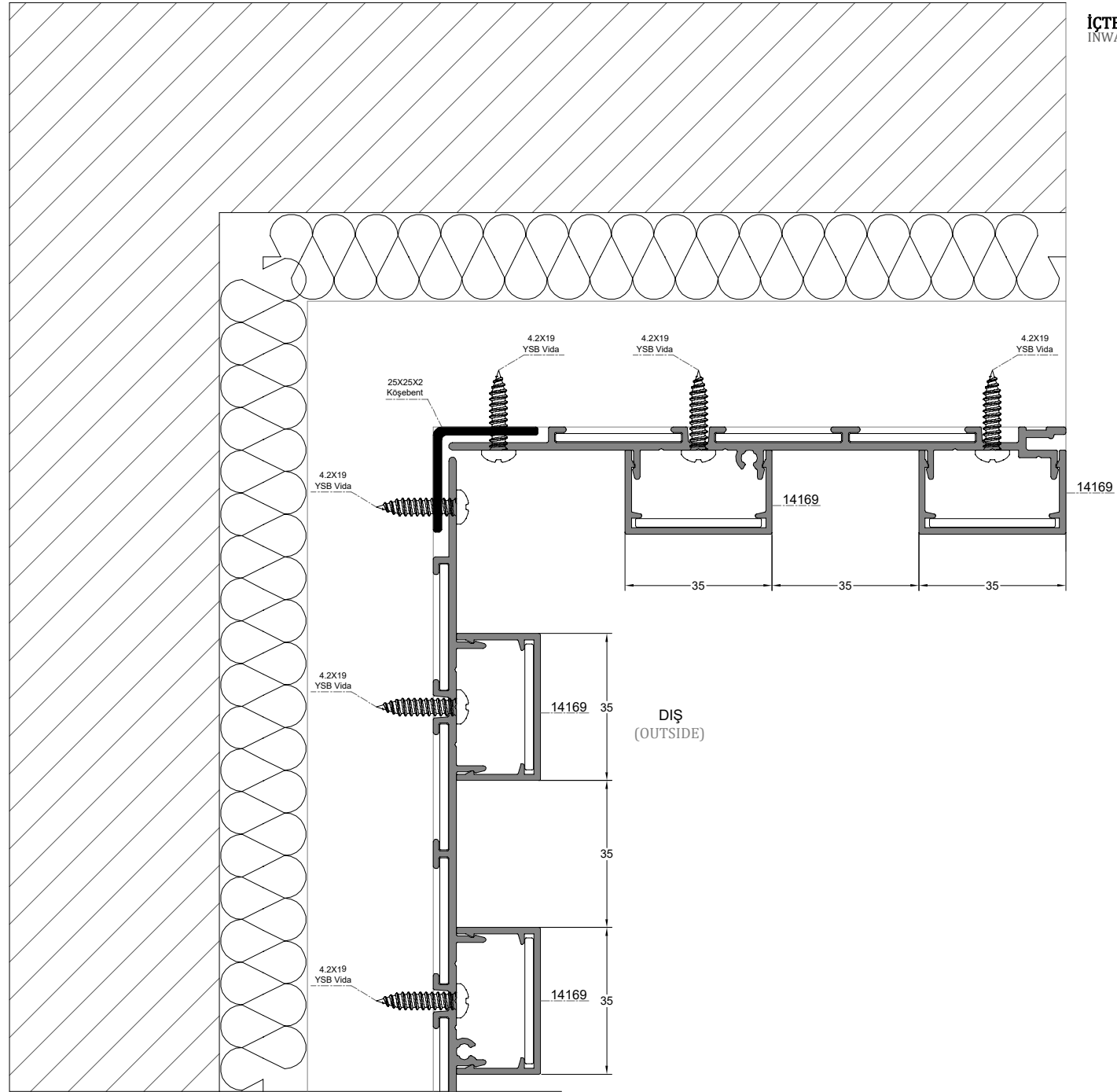

ART-CV-40

KAPAK

FONKSIYONLARI

ART-CV-40

COVERED

FUNCTIONS

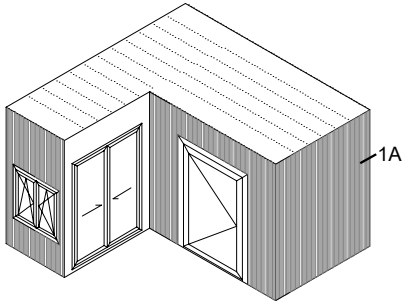

İÇ
(INSIDE)

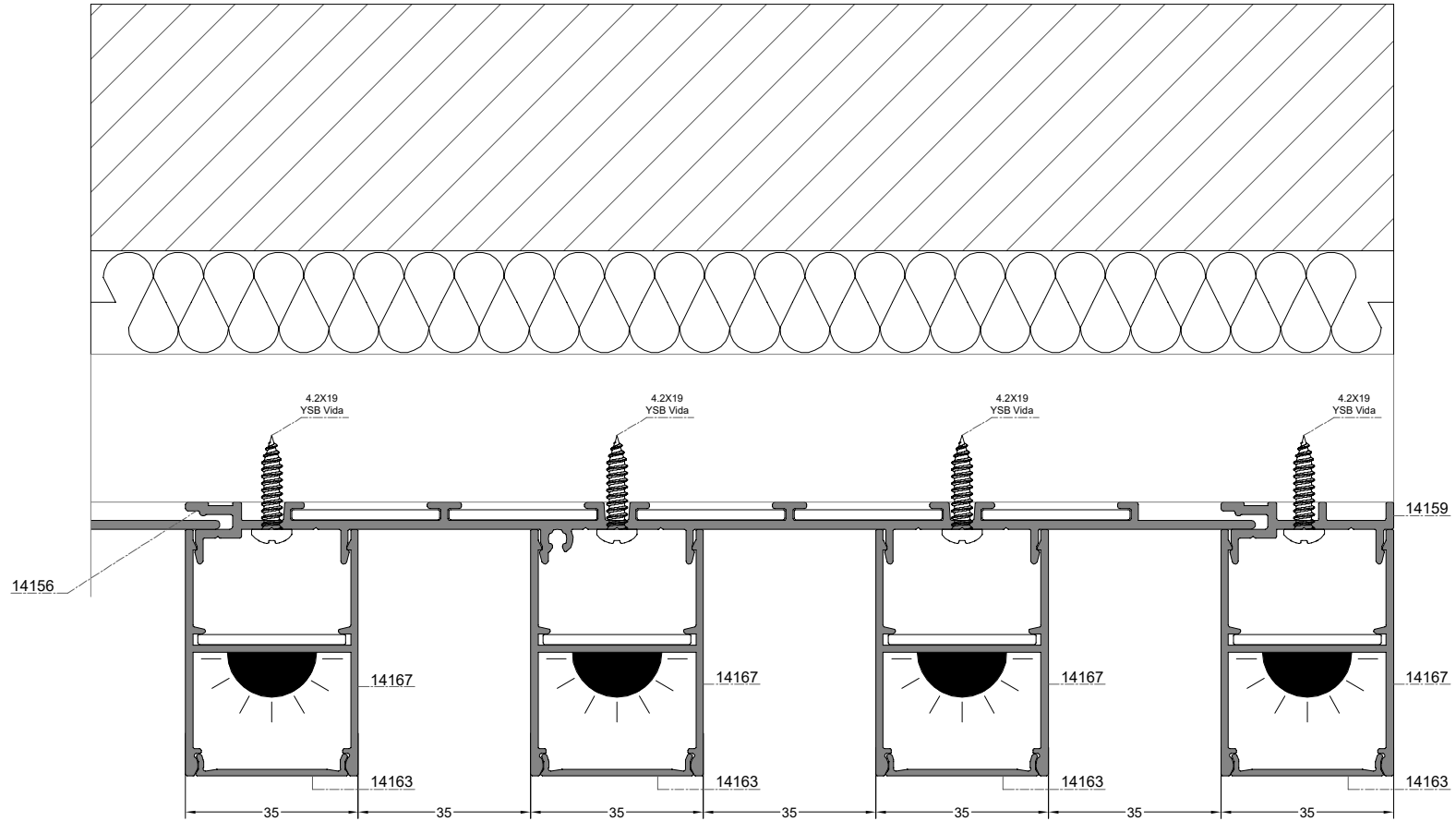

DIŞ
(OUTSIDE)

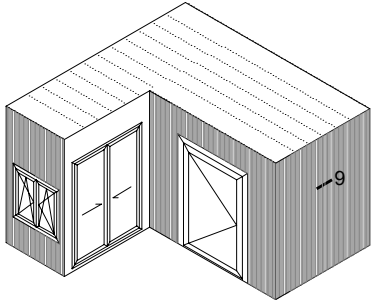

İÇ
(INSIDE)

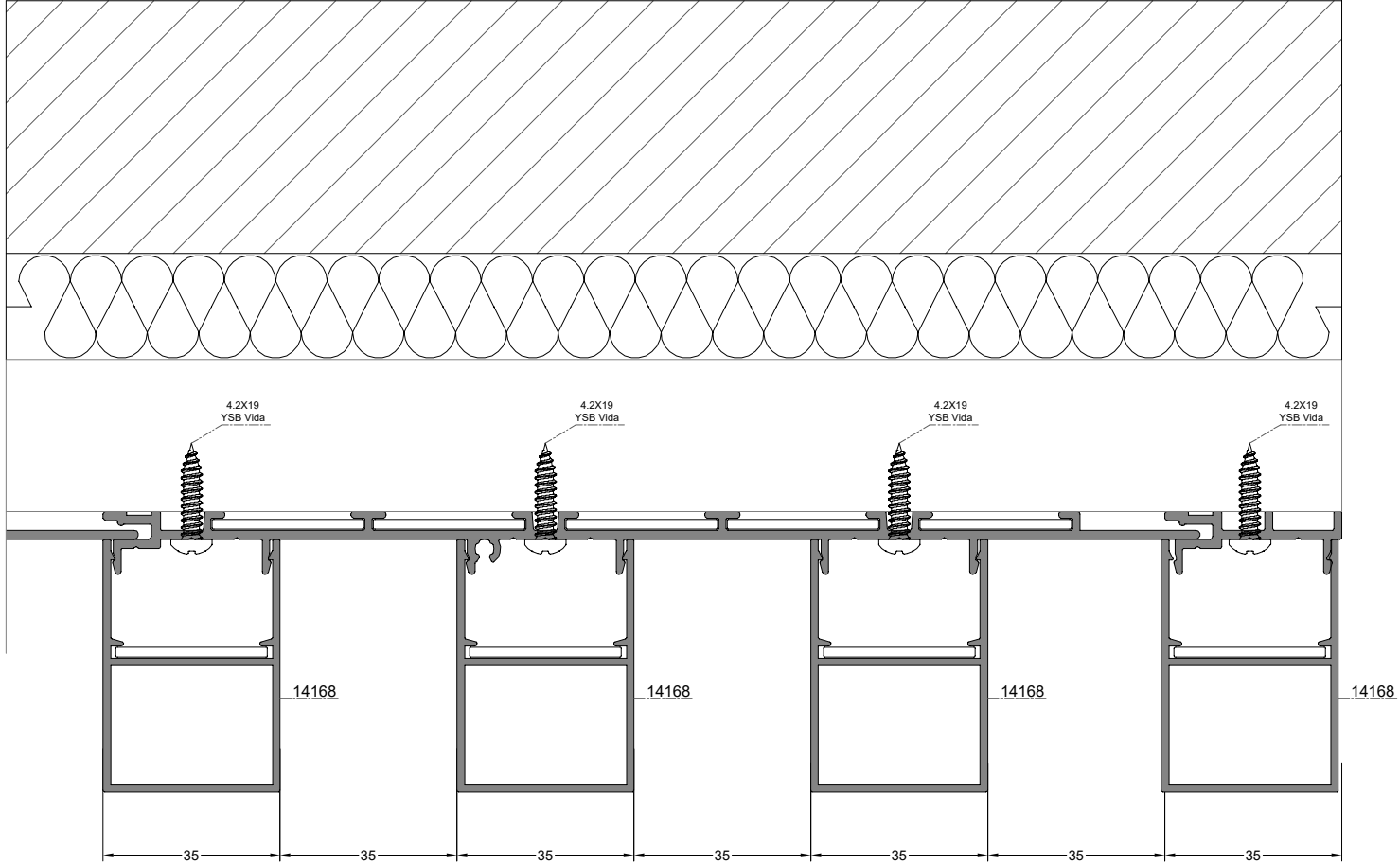

DIŞ
(OUTSIDE)

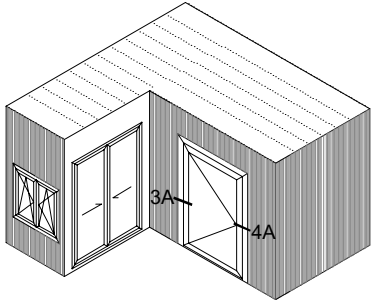

İÇ
(INSIDE)

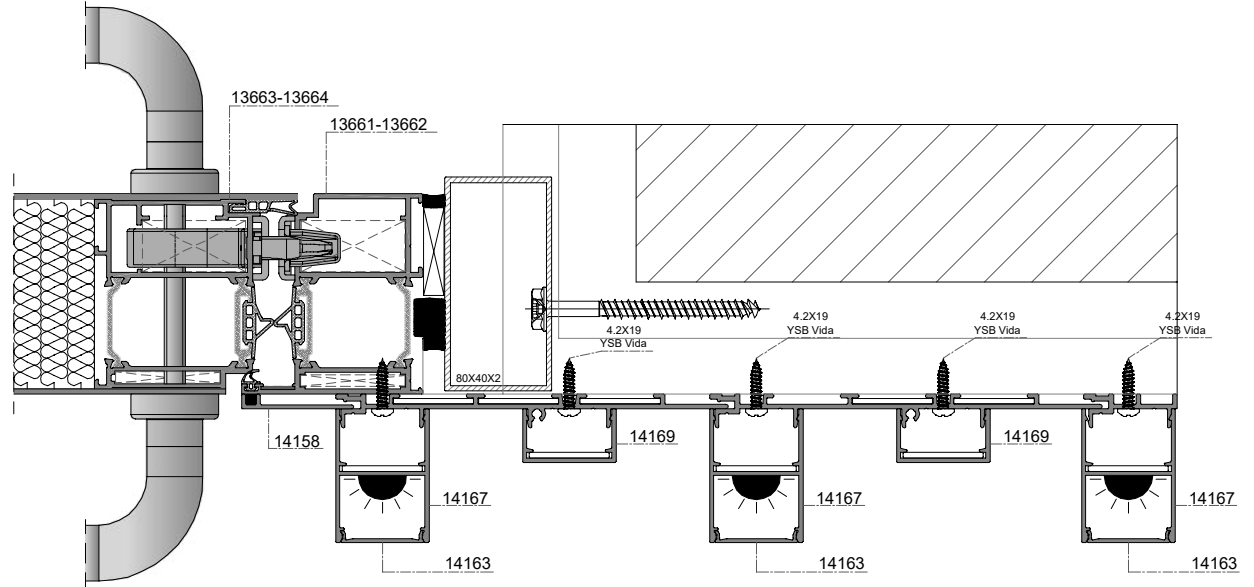
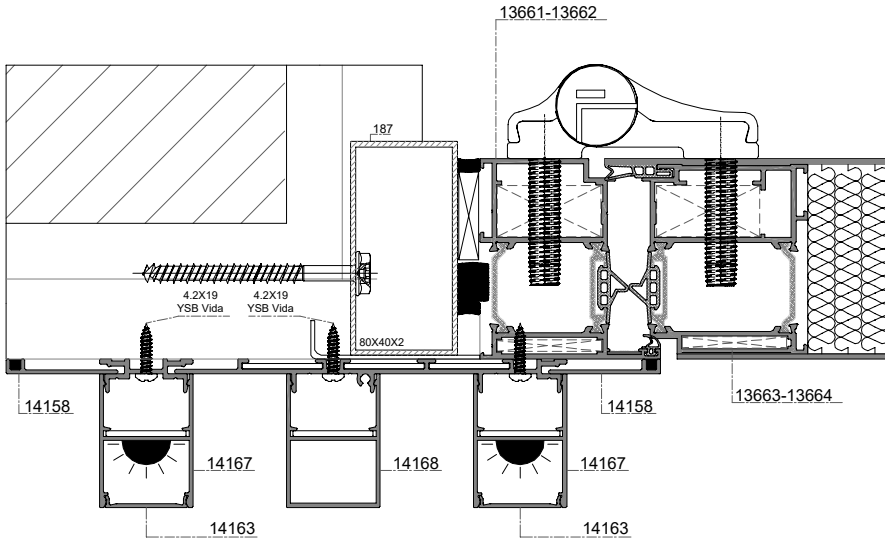

DIŞ
(OUTSIDE)

D-3A

D-4A

ÖLÇEK: 1/2
SCALE: 1/2

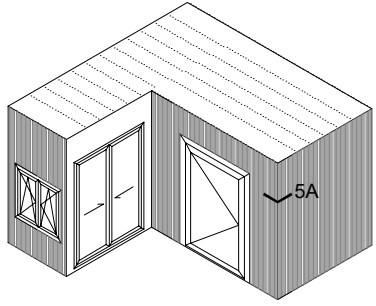

İÇ
(INSIDE)

DIŞTAN KÖŞE DÖNÜŞ DETAYI
OUTWARD COVERED DETAIL

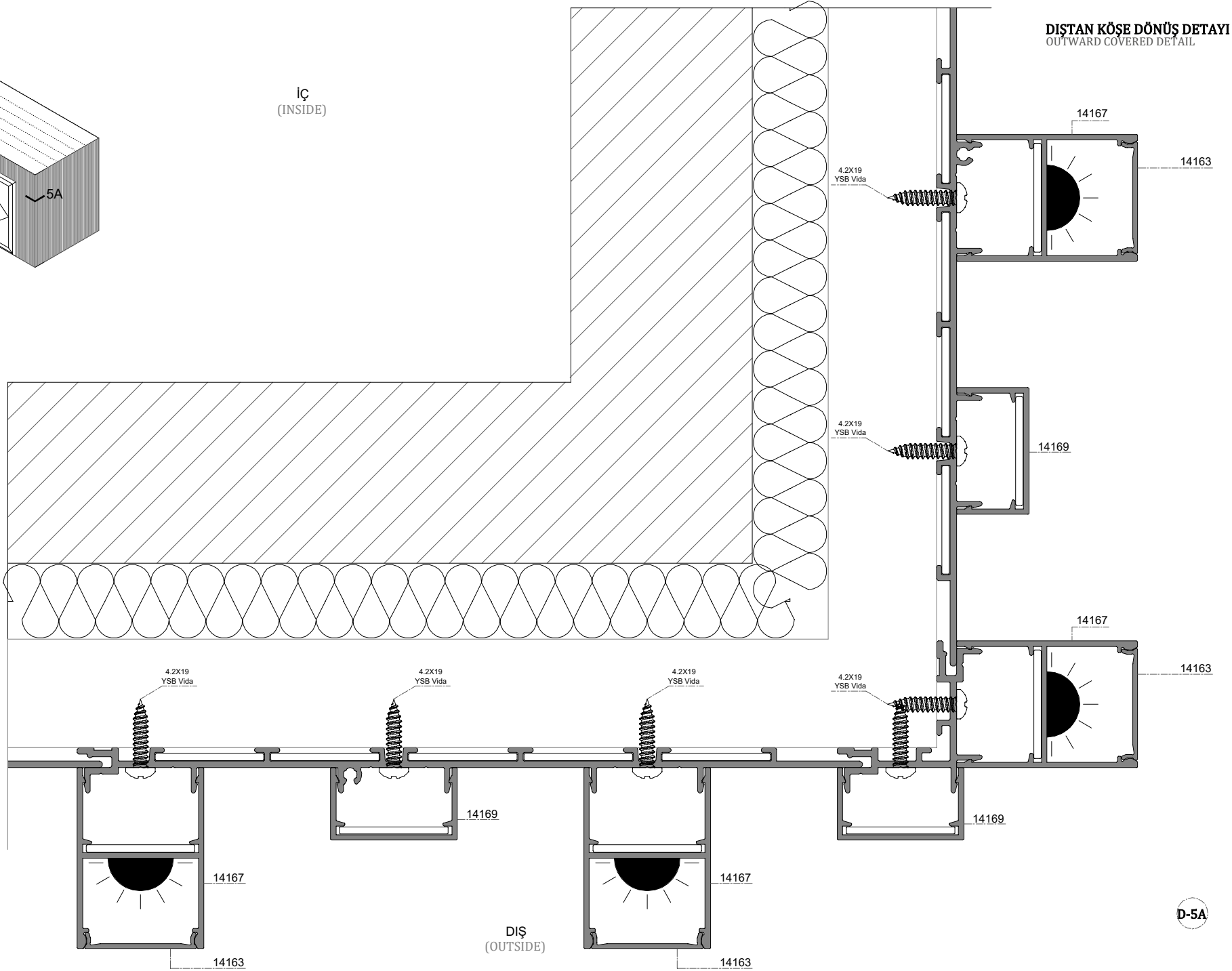

120° KÖŞE DÖNÜŞ DETAYI
120° COVERED DETAIL

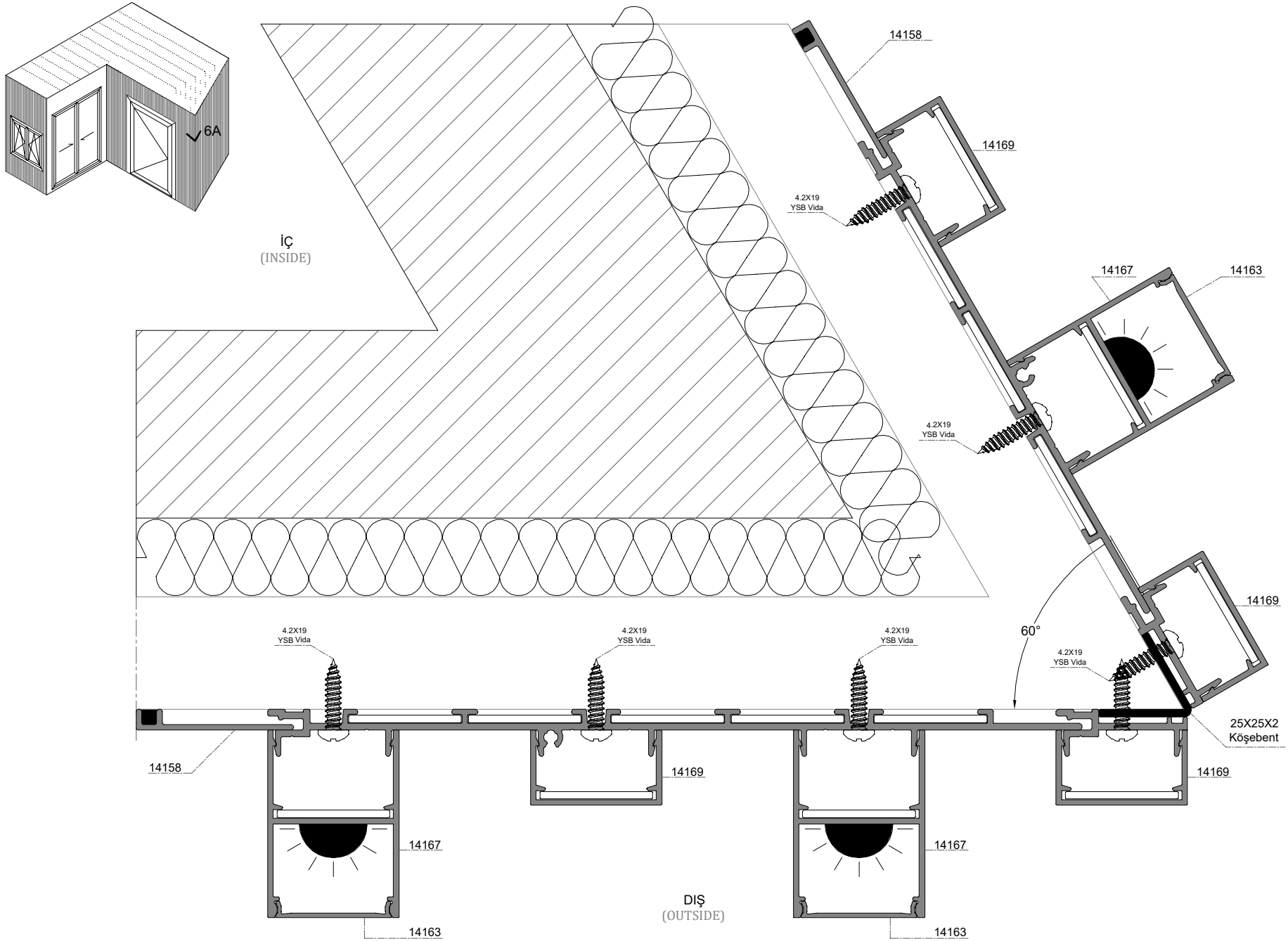

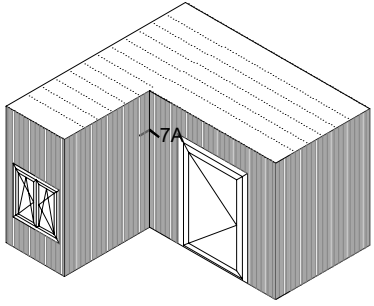

İÇ
(INSIDE)

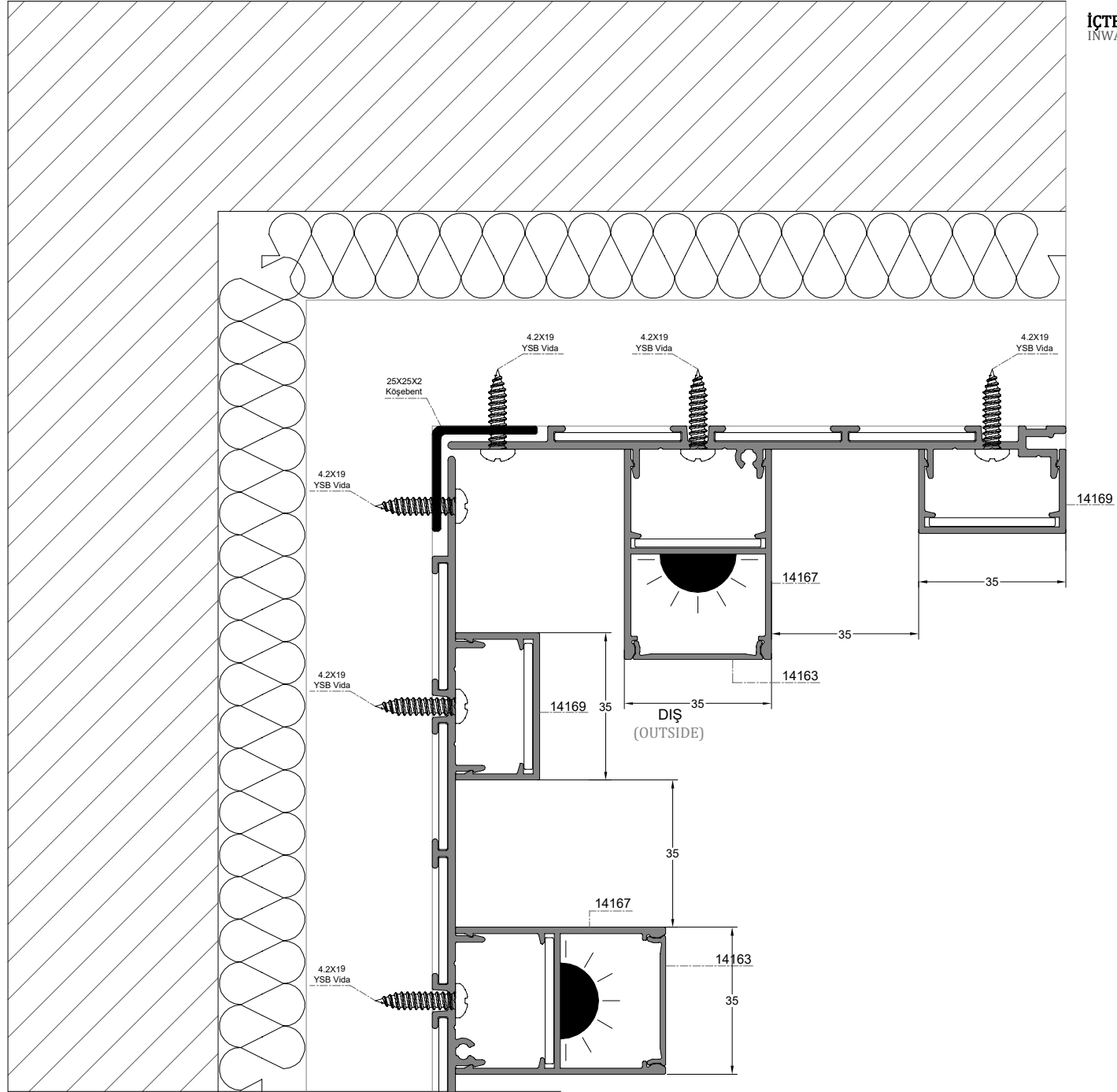

ART-CV-90

KAPAK

FONKSIYONLARI

ART-CV-90

COVERED

FUNCTIONS

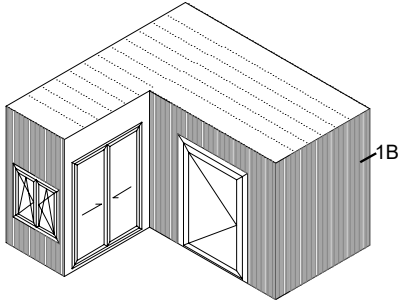

İÇ
(INSIDE)

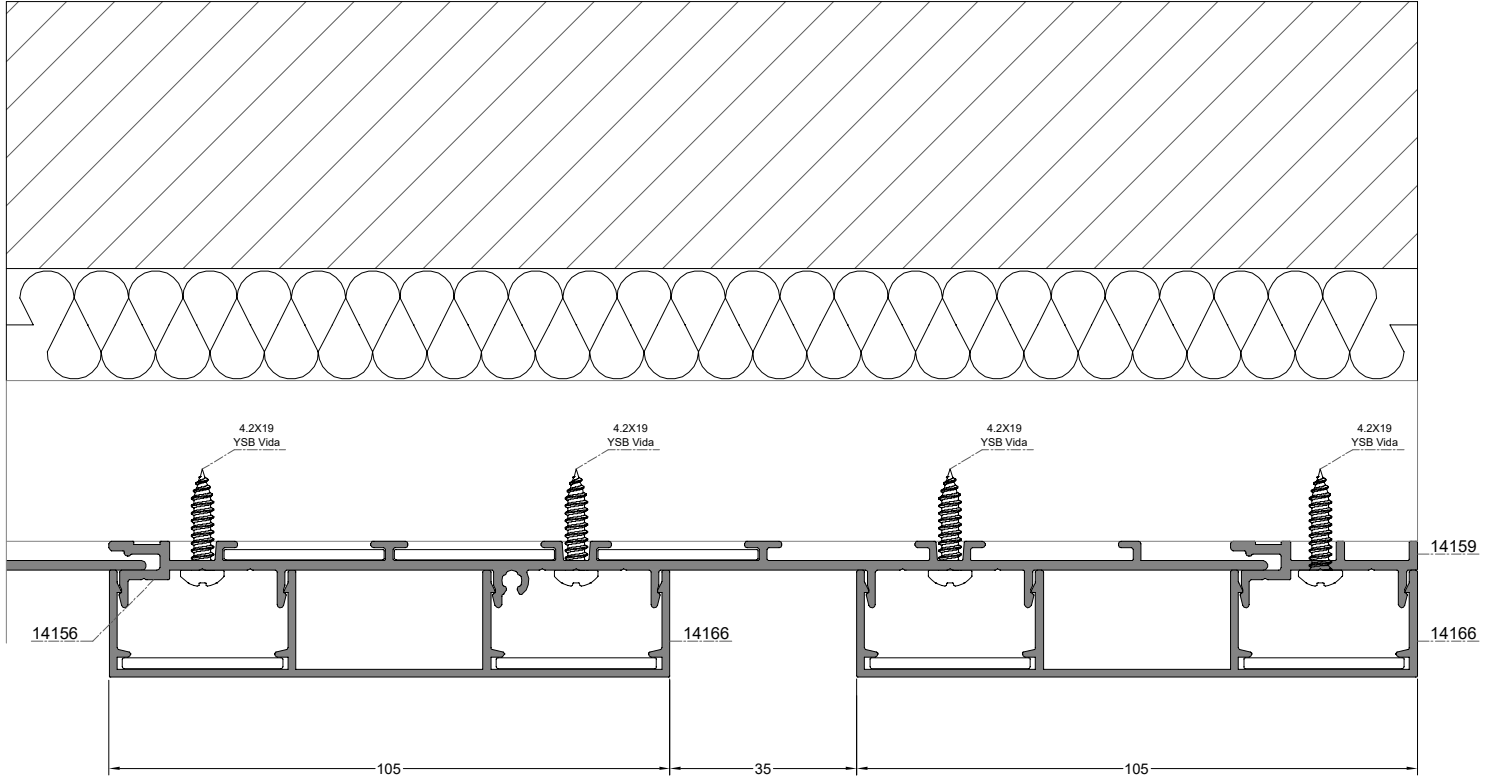

DIŞ
(OUTSIDE)

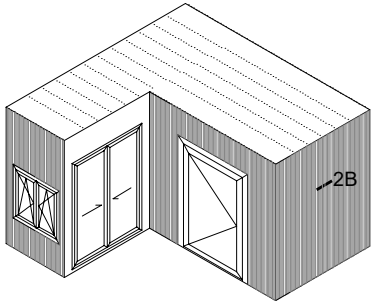

İÇ
(INSIDE)

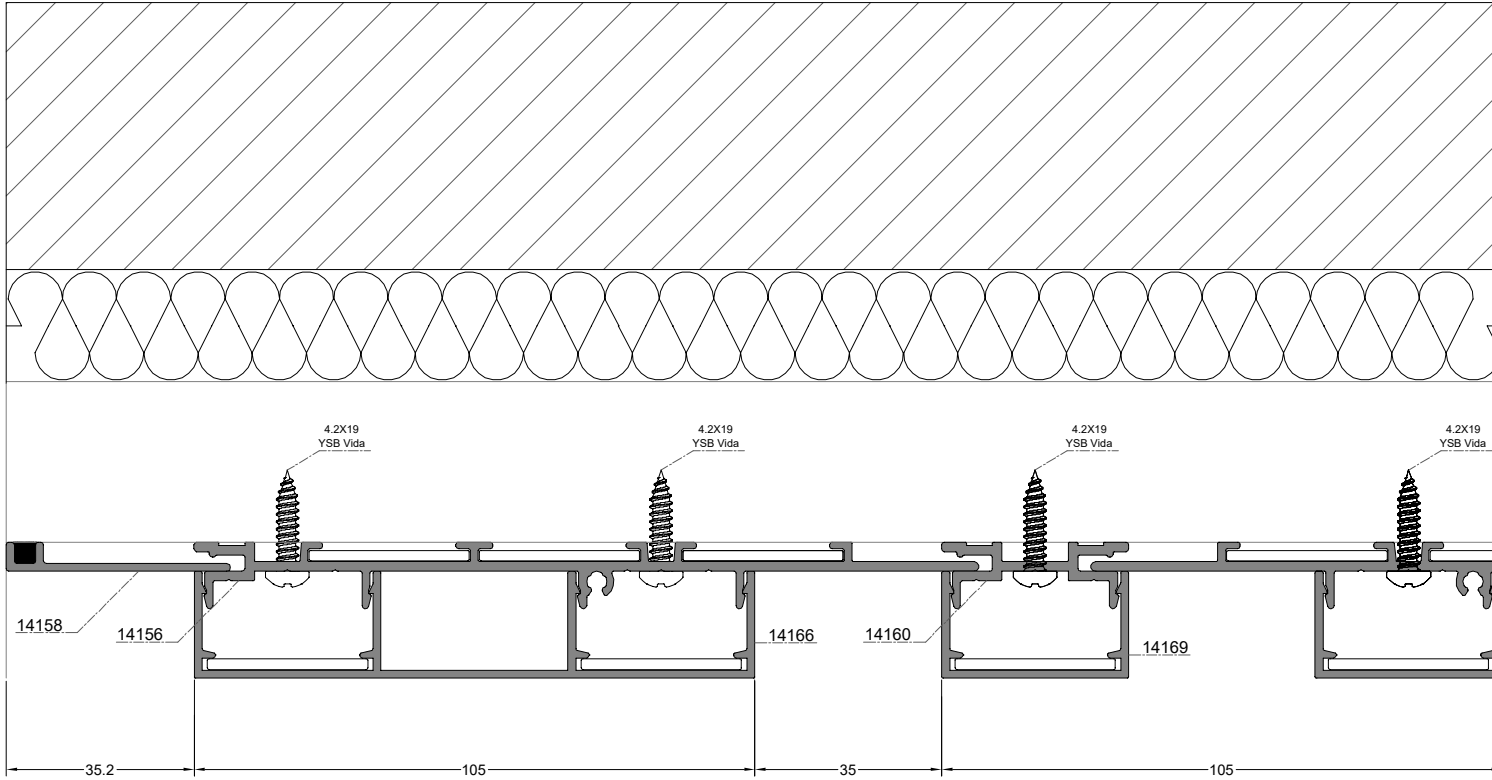

DIŞ
(OUTSIDE)

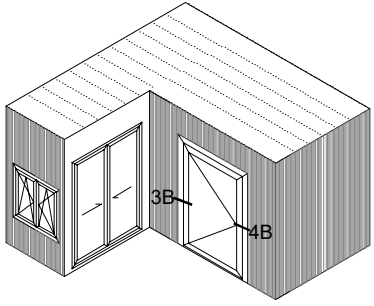

İÇ
(INSIDE)

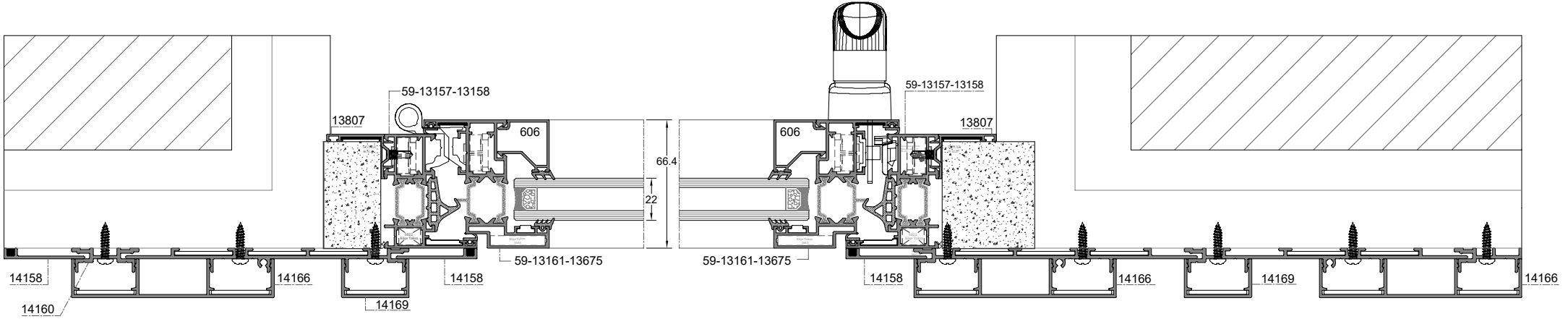

D-3B

DIŞ
(OUTSIDE)

D-4B

ÖLÇEK: 1/2
SCALE: 1/2

120° KÖŞE DÖNÜŞ DETAYI
120° COVERED DETAIL

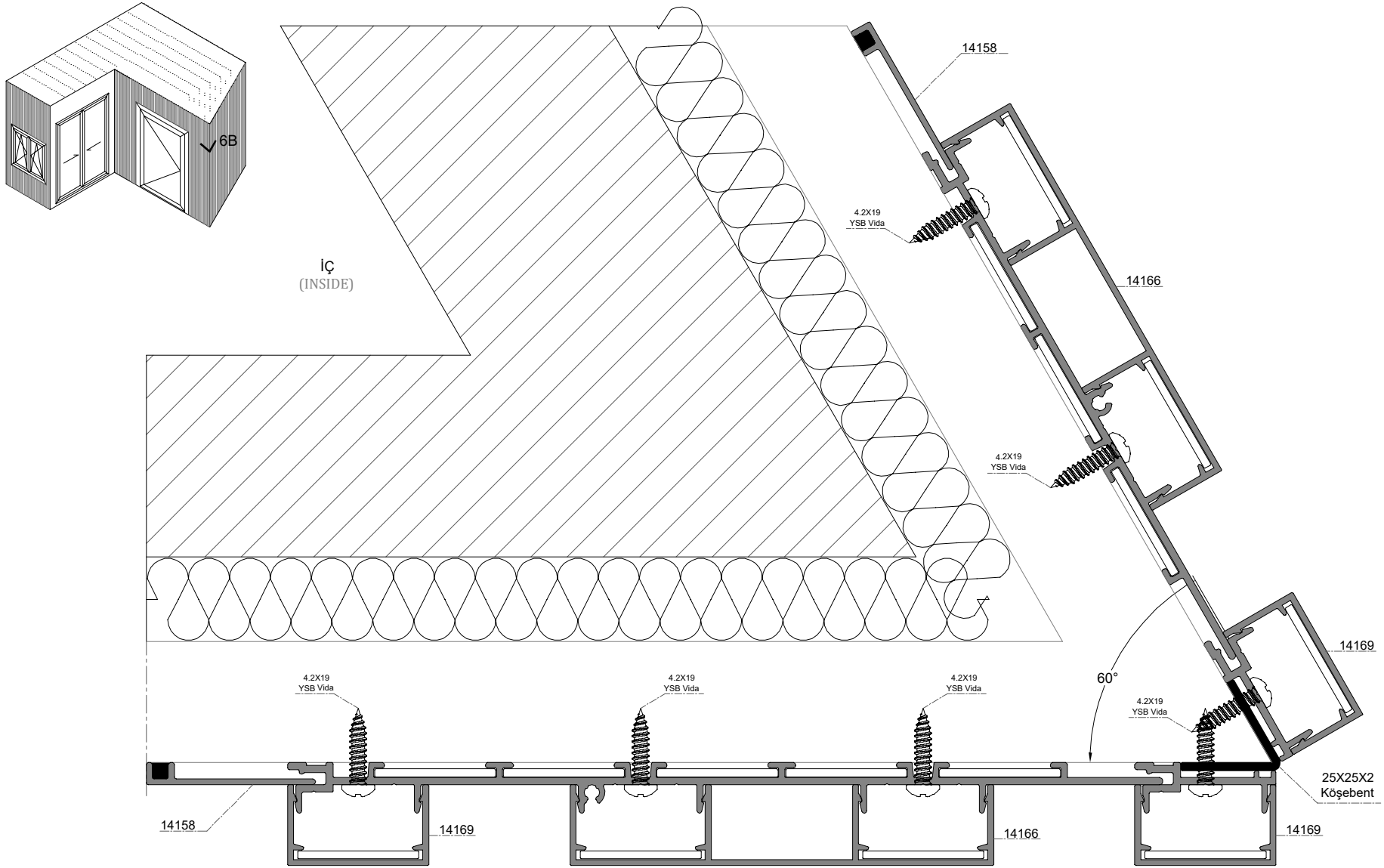

İÇTEN KÖŞE DÖNÜŞ DETAYI
INWARD COVERED DETAIL

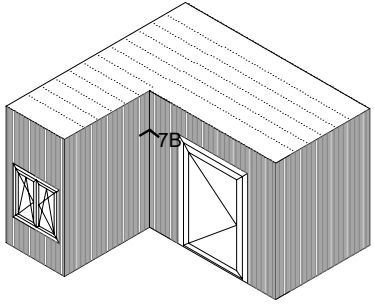

İÇ
(INSIDE)

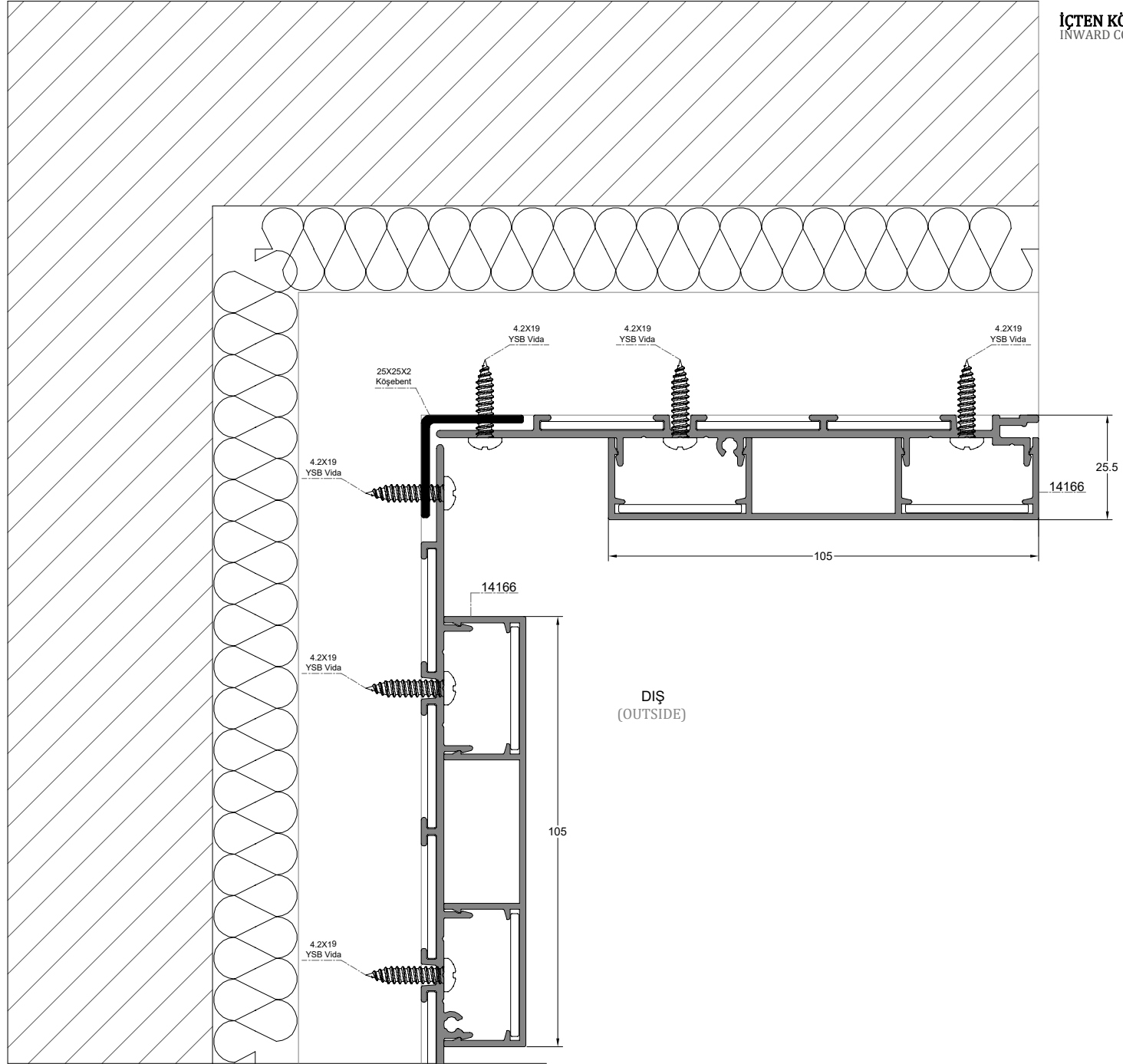

ART-CV-65

KAPAK

FONKSIYONLARI

ART-CV-65

COVERED

FUNCTIONS

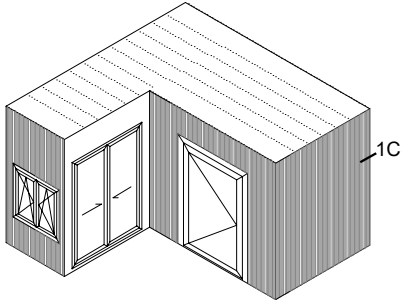

İÇ
(INSIDE)

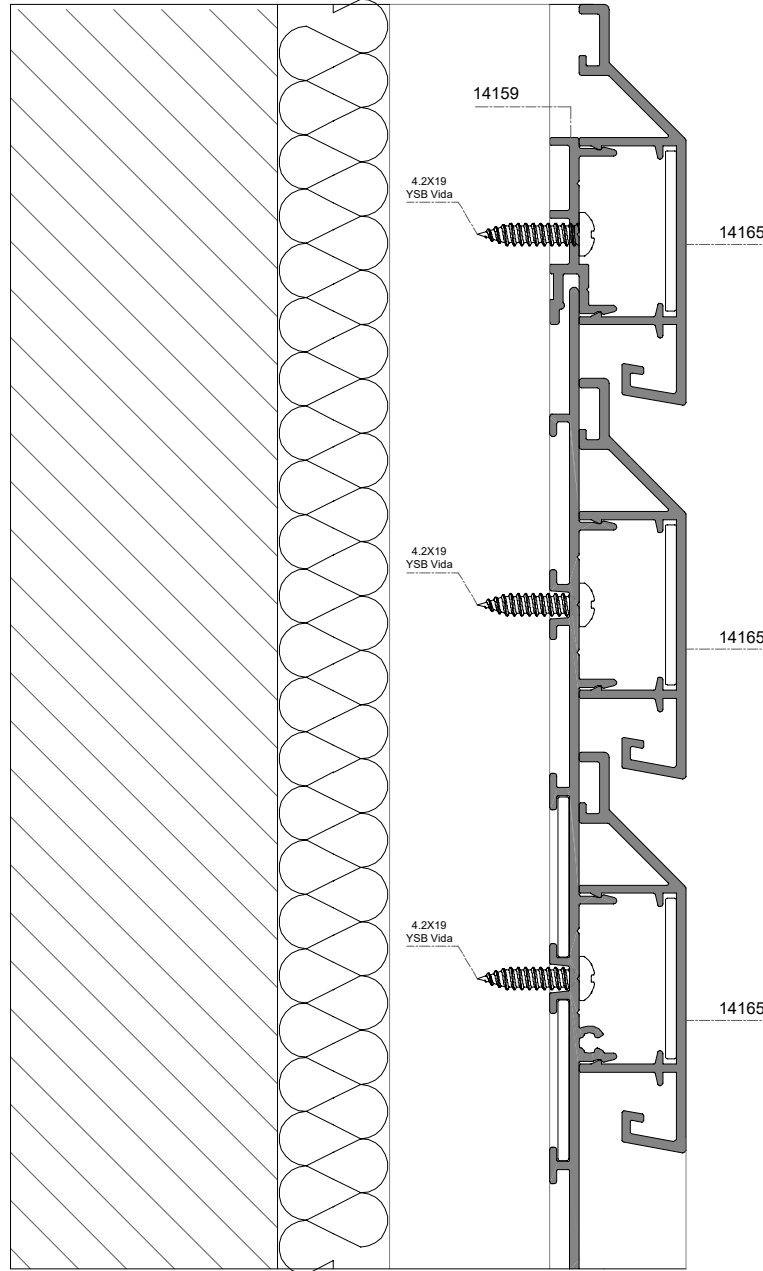

DIŞ
(OUTSIDE)

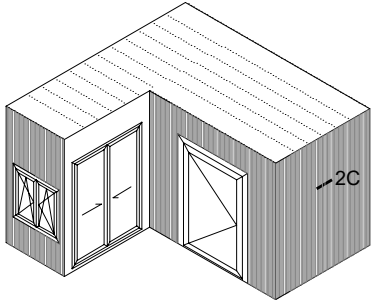

İÇ
(INSIDE)

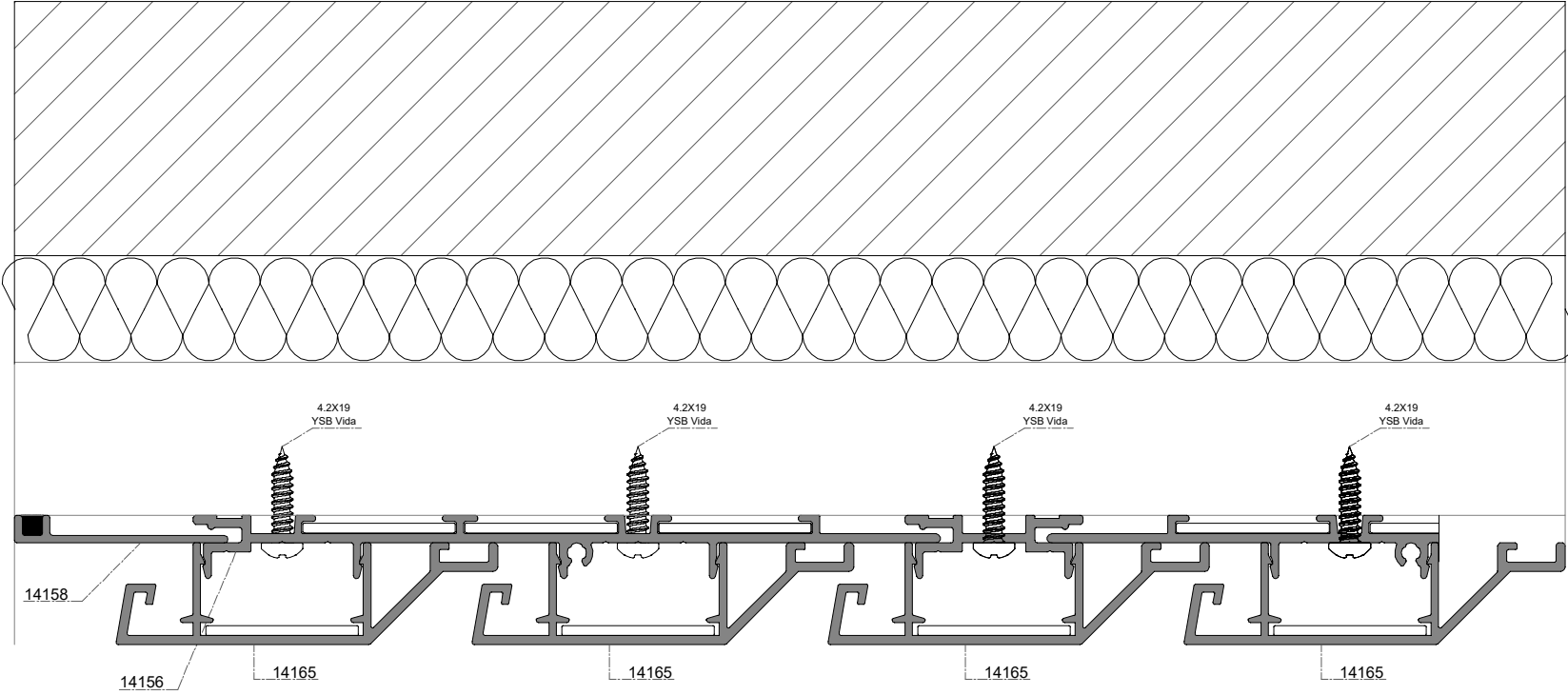

DIŞ
(OUTSIDE)

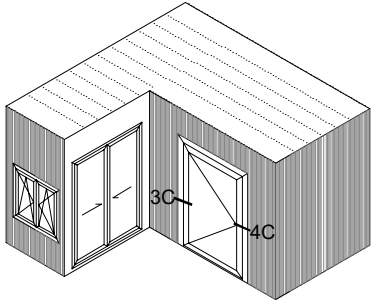

İÇ
(INSIDE)

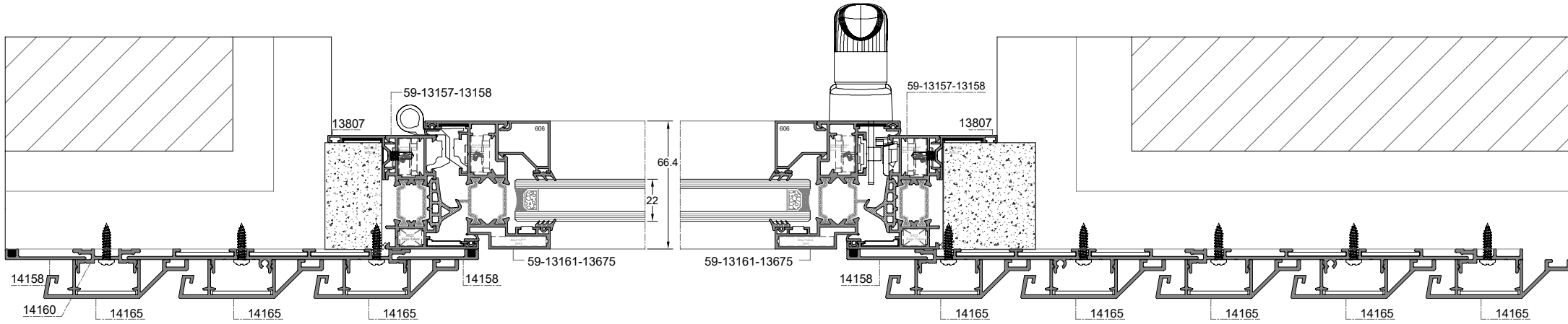

D-3C

DIŞ
(OUTSIDE)

D-4C

ÖLÇEK: 1/2
SCALE: 1/2

120° KÖŞE DÖNÜŞ DETAYI
120° COVERED DETAIL

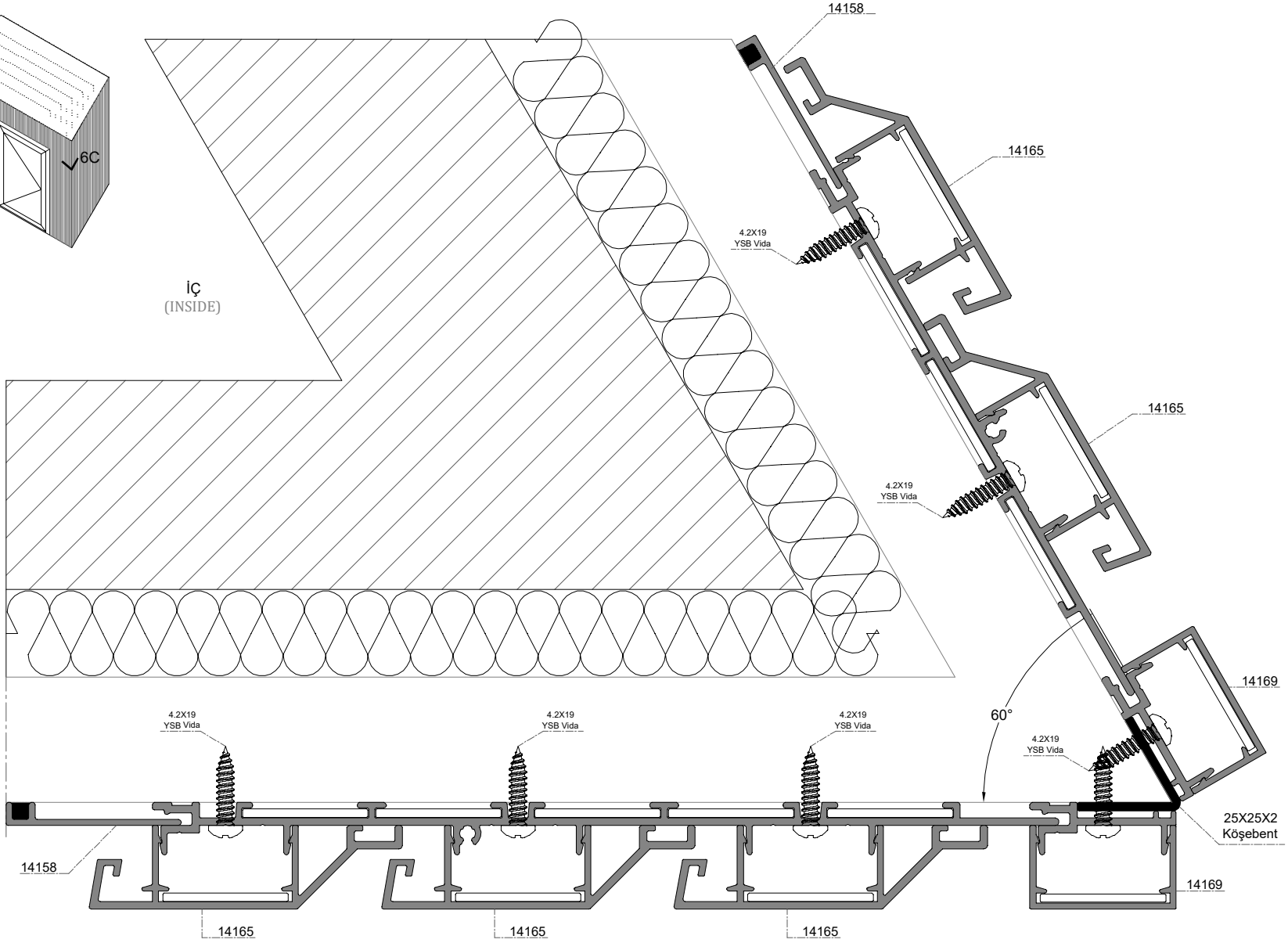
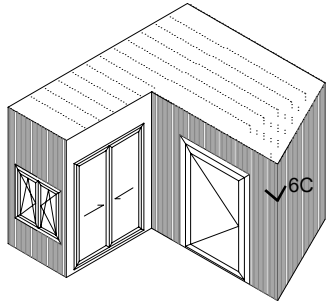

DIŞ
(OUTSIDE)

İÇTEN KÖŞE DÖNÜŞ DETAYI
INWARD COVERED DETAIL

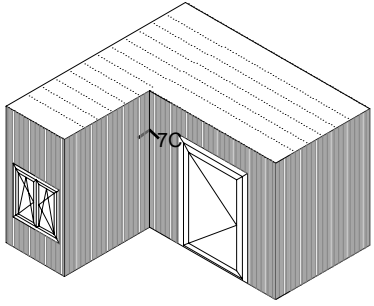

İÇ
(INSIDE)

